

**eWON4101™**

**VPN Router  
Remote Access Server (RAS)  
Programmable Industrial Router (PIR)**

# Installation Guide

Rev. 1.0.3



*Cool  
Internet  
Telecontrol  
Solutions*

**VPN Router  
Remote Access Server (RAS)  
Programmable Industrial Router (PIR)**

**Table of Contents**

1 Product description .....	4
1.1 Introduction .....	4
1.2 General specification of the hardware platform .....	4
1.3 Functions of the eWON4101™ .....	4
1.4 Typical applications .....	5
1.5 Part Numbers and internal options .....	5
1.6 External accessories .....	6
2 Structure of the eWON technical documentation .....	7
3 Housing and markings.....	8
3.1 Housing Interfaces .....	8
3.2 Markings .....	9
3.3 Applicable directives, standards and compliance.....	9
3.4 Equipment information and versions.....	10
3.5 Mechanical outline .....	11
3.6 Mounting and environmental conditions .....	12
3.7 Preparing the installation .....	12
3.8 Specification for external power supply selection.....	12
4 Front panel control LEDs .....	13
5 Communication interfaces and I/Os .....	14
5.1 Ethernet Port .....	14
5.2 Embedded PSTN Modem .....	14
5.3 Embedded GSM/GPRS Modem .....	14
5.4 Embedded ISDN Modem .....	15
5.5 Resets.....	16
5.6 Configurable serial port .....	17
5.7 MPI port .....	18
5.8 Digital input .....	19

**VPN Router  
Remote Access Server (RAS)  
Programmable Industrial Router (PIR)**

5.9 Digital output .....	20
6 Communicating with the eWON .....	21
6.1 By Ethernet.....	21
6.2 By phone line or GSM.....	21
7 IP parameters configuration.....	23
8 Technical support .....	24
9 Appendix: Pinouts and connections .....	24
9.1 Power Supply .....	24
9.2 Ethernet .....	25
9.3 RJ45 connector.....	28
9.4 Input/Outputs .....	29
9.5 Serial Port .....	30
9.6 MPI port .....	31
9.7 Unitelway/Modbus serial cable .....	32
9.8 PSTN / ISDN phone line connector .....	33

---

## 1 Product description

---

### 1.1 Introduction

The eWON4101™ is a compact version from a complete range of Ethernet/Internet gateways also known as “Programmable Industrial Routers” (PIR). See our web site <http://www.ewon.biz> to get further information about the eWON range. The eWON is a terminal that enables access to technical data, whatever their format is. It is configurable by web pages. It is secure because it meets the toughest industrial standards and has restricted access features (required in open networks). The hardware platform of the eWON4101™ is a standard eWON that embeds a modem (PSTN or GSM/GPRS).

The eWON range supports the TCP/IP and PPP protocols. This brings you all the benefits of an universally recognized standard network. It also allows you to use popular software tools like Internet Explorer, FTP client, SNMP Manager, Mail Recipient... and so to reduce significantly your costs (implementation and ownership).

### 1.2 General specification of the hardware platform

- Processor ARM clocked @ 75Mhz, 16Mb SDRAM, 16 Mb Flash
- Backed up real time clock (RTC) with 24 Hours autonomy
- Battery with 10 years autonomy (for RTC)
- External power supply 12-24 VDC +/- 20%
- 1 Ethernet port 10/100Mb BaseTx
- 1 Serial port configurable in RS232/RS422/RS485  
OR  
1 MPI port
- 1 digital input (DI)
- 1 digital output (DO)
- DIN rail mounting compliant with EN50022 (latch)
- Environmental conditions (operating):  
Ambient T°: from 0°C to +50°C  
Humidity: from 0 to 80% non condensing

### 1.3 Functions of the eWON4101™

#### 1.3.1 General

- Ethernet Gateway to serial protocols
- Data acquisition
- viewON compatible
- Web server – fully customizable web pages
- Programmable by BASIC scripts
- Alarm management
- Report generation

#### 1.3.2 Virtual Private Network

- Allow to build your own Virtual Private Network (VPN) thanks to OpenVPN technology

#### 1.3.3 Remote Access Server functions

- Remote Access Server (RAS) and TCP/IP Server
- PAP/CHAP Authentication
- Login/password
- Remote network access
- User access control
- Security: Integrated firewall (NAT, IP filtering)

- Conventional and internet callback

### **1.3.4 Ethernet Gateway**

- Compatibility with MODBUS, UNITELWAY, NETMPI, DF1, EIP, FINS and S5 AS511 protocols

### **1.3.5 Programmable Industrial Router functions**

- Automatic routing of protocols
- Pre-configured routing tables
- Programmable routing from I/O and Tag names (BASIC)

## **1.4 Typical applications**

- Datalogging
- Alarm management
- Sending alarms by network, phone, Email and/or SMS
- Remote measurements, loop back, control and monitoring
- Local or remote Human Machine Interface (SCADA)
- Predictive and operational maintenance
- Diagnosis and machinery status control
- Stock and vessel level monitoring
- Process and machinery activity logs
- Commissioning support
- Remote programming
- Interface for Application Service Providers (ASP)

## **1.5 Part Numbers and internal options**

Part Number structure of the eWON product range:

**EWaabzm**

Where (examples):

### **aa = Type of hardware platform**

- 43 = eWON4101™

### **b = Power supply**

- 2 = Low voltage DC power supply

### **z = Serial port type**

- 0 = RS232 / RS422 / RS485 serial port
- 6 = MPI port

### **m = Communication**

- 03 = ISDN modem
- 04 = PSTN56 modem
- 05 = GSM/GPRS modem
- 06 = GSM/GPRS modem US

Available Part Numbers for the eWON4101™ platform:

Type/Description	Part Number
eWON4101™/PSTN56 (PSTN modem)	EW43204
eWON4101™/ISDN (ISDN modem)	EW43203
eWON4101™/GSM/GPRS (GSM/GPRS modem)	EW43205
eWON4101™/GSM/GPRS US (GSM/GPRS modem)	EW43206
eWON4101™/PSTN56 (PSTN) with MPI port	EW43264

Table 1: List of available Part Numbers

## 1.6 External accessories

External accessories available for the eWON4101™ platform

Description	Part Number
Starter Kit (Eth cables: 1 straight, 1 crossed + CDROM)	EW40901
Antenna GSM/GPRS (dual band fixing by screw)	EW40902
Antenna adapter SMA-M/FME-M	EW40908
Serial cable 2m for Schneider SUBD9--MiniDIN	EW40906

Table 2: Available external accessories

## 2 Structure of the eWON technical documentation

The eWON technical documentation is structured in 4 different levels as shown in the table below:

Level	Title	Contents
1	Hardware <b>Installation Guide</b> (the present document) (~40pp)	Detailed description of the hardware platform, of its interfaces, available options and accessories. Hardware specifications, conformity to standards. Installation recommendations and pinout of the connectors. Step-by-step tutorial to establish first communications and make the IP configuration.  Exists for the following platforms: <ul style="list-style-type: none"> <li>• eWON1000, 2000, 4000</li> <li>• eWON500, 2001, 4001, 4002</li> <li>• eWON2101, 4101, 2005, 4005</li> </ul>
2	Software <b>Getting Started</b> (~30pp)	Manual to start using the basic functions of the eWON software. Covers most usual applications (eWON 4000 only).
3	Software <b>User Manuals</b> (~250pp)	Exhaustive manual to use all advanced functions of the eWON. Contains BASIC and HTML syntax.  (Exists for all platforms)
4	<b>Application Notes</b> <b>Technical Notes</b>	<ul style="list-style-type: none"> <li>• Unitelway topology Gateway XIP</li> <li>• Unitelway for Schneider PLC,</li> <li>• Gateway MPI for Siemens PLC and Gateway for IP devices</li> <li>• Etc, etc.</li> </ul>

Table 3: eWON technical documentation different levels

All those manuals are available for download in pdf format on the eWON website: <http://www.ewon.biz>.

## 3 Housing and markings

### 3.1 Housing Interfaces

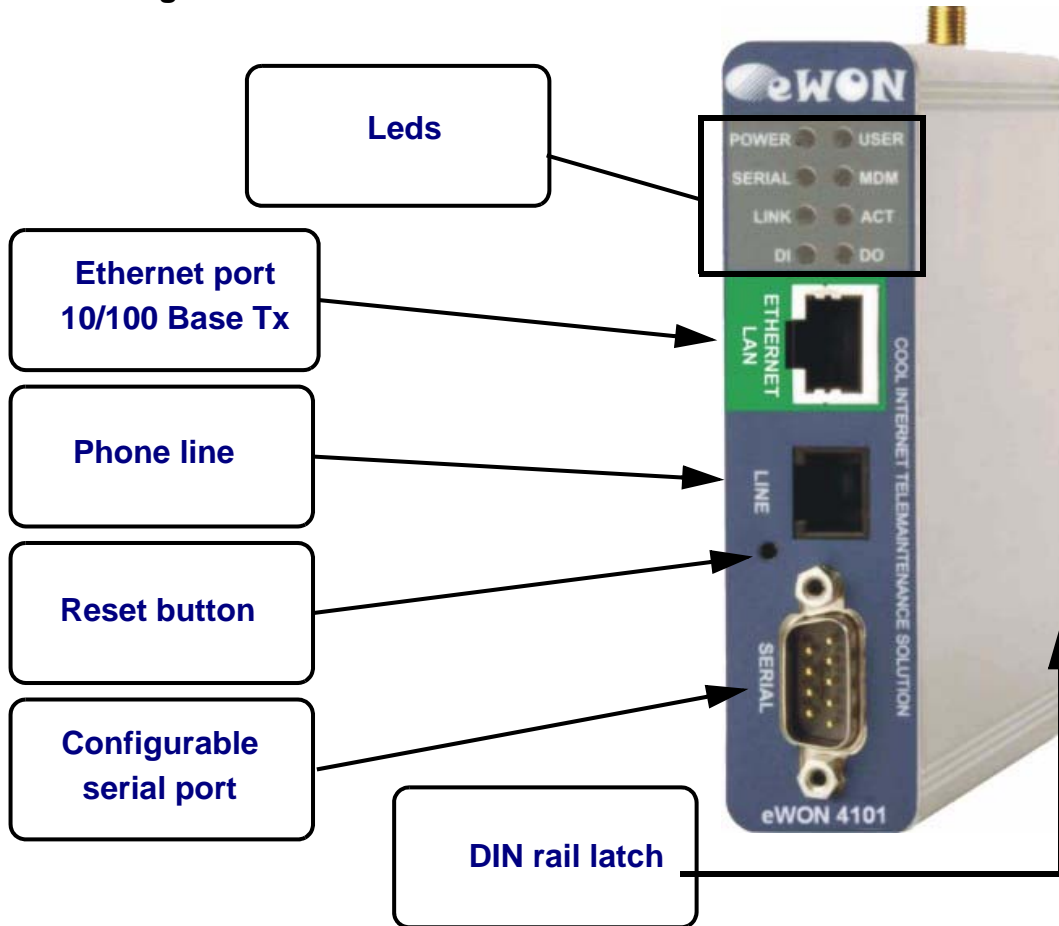

Figure 1: Housing, front view

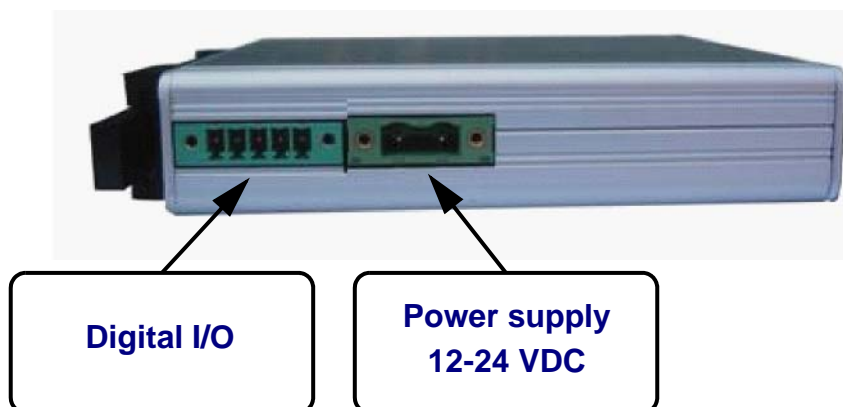

Figure 2: Housing, bottom view



## 3.2 Markings

The identification label of the eWON is placed at the left hand side of the housing. The label is composed of the following fields:

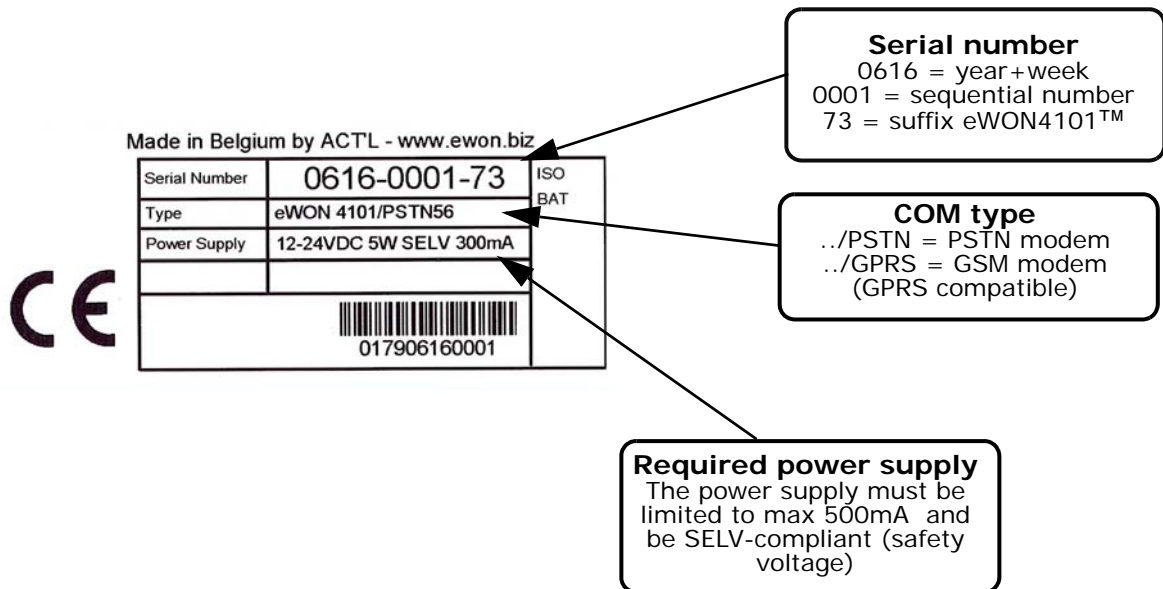

Figure 3: eWON Label

The eWON Serial Number (SN) is an important traceability tool both for the user and for the manufacturer. Therefore, next to the product label, each eWON has its serial number stored in the flash memory. This SN is also used in order to scan the network for eWONs and to assign its IP address, subnet mask and gateway. For more details, [See "Equipment information and versions" on page 10.](#)

## 3.3 Applicable directives, standards and compliance

- 93/68/EEC European directive for CE-mark
- 73/23/EEC European directive for the safety of low voltage equipment (LVD) – Applicable standard is EN60950 A1+A4+A11
- 89/336/EEC amended by 92/31/EEC European directives for the electromagnetic compatibility (EMC) – Applicable standards EN55022:94 A1, A2 (emissions) and EN55024:98 (immunity)
- UL/CSA certification in progress (UL60950)

### 3.4 Equipment information and versions

The eWON hardware and software revisions can be checked with a web browser on the eWON server (see *Communicating with the eWON on page 21*). Once logged onto the eWON, clicking on the eWON logo shows these revisions.

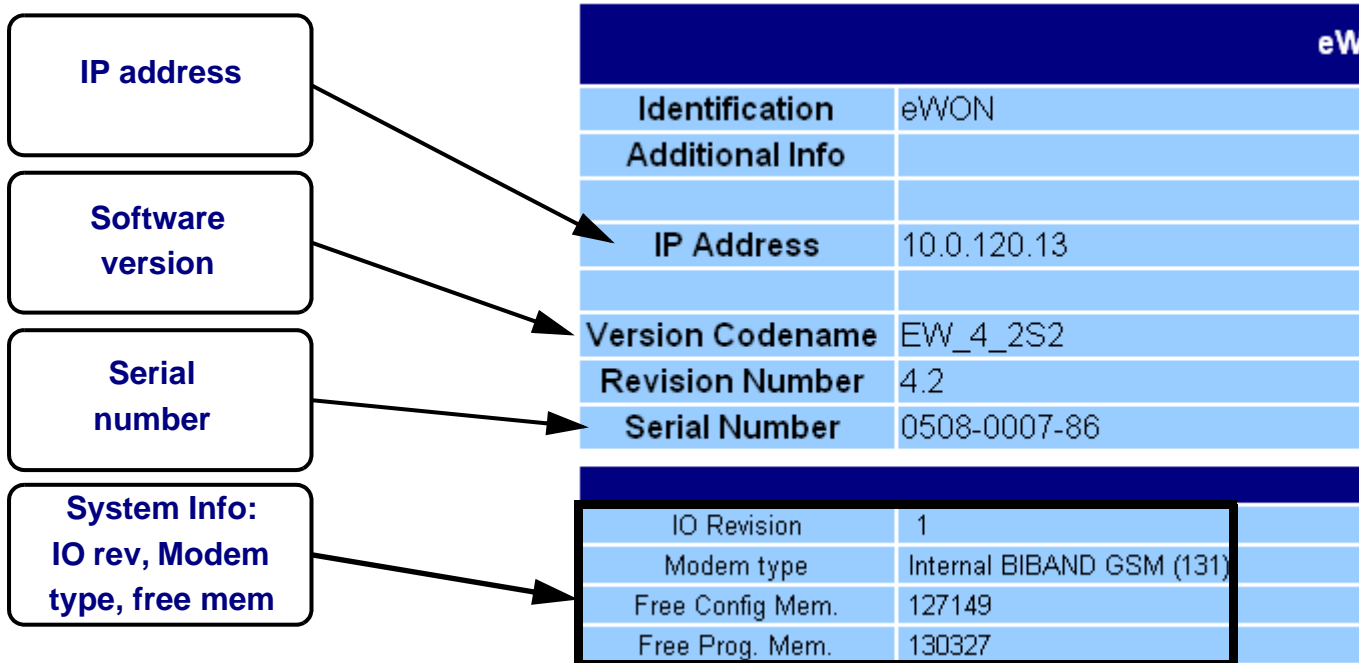

Figure 4: eWON info page details

## 3.5 Mechanical outline

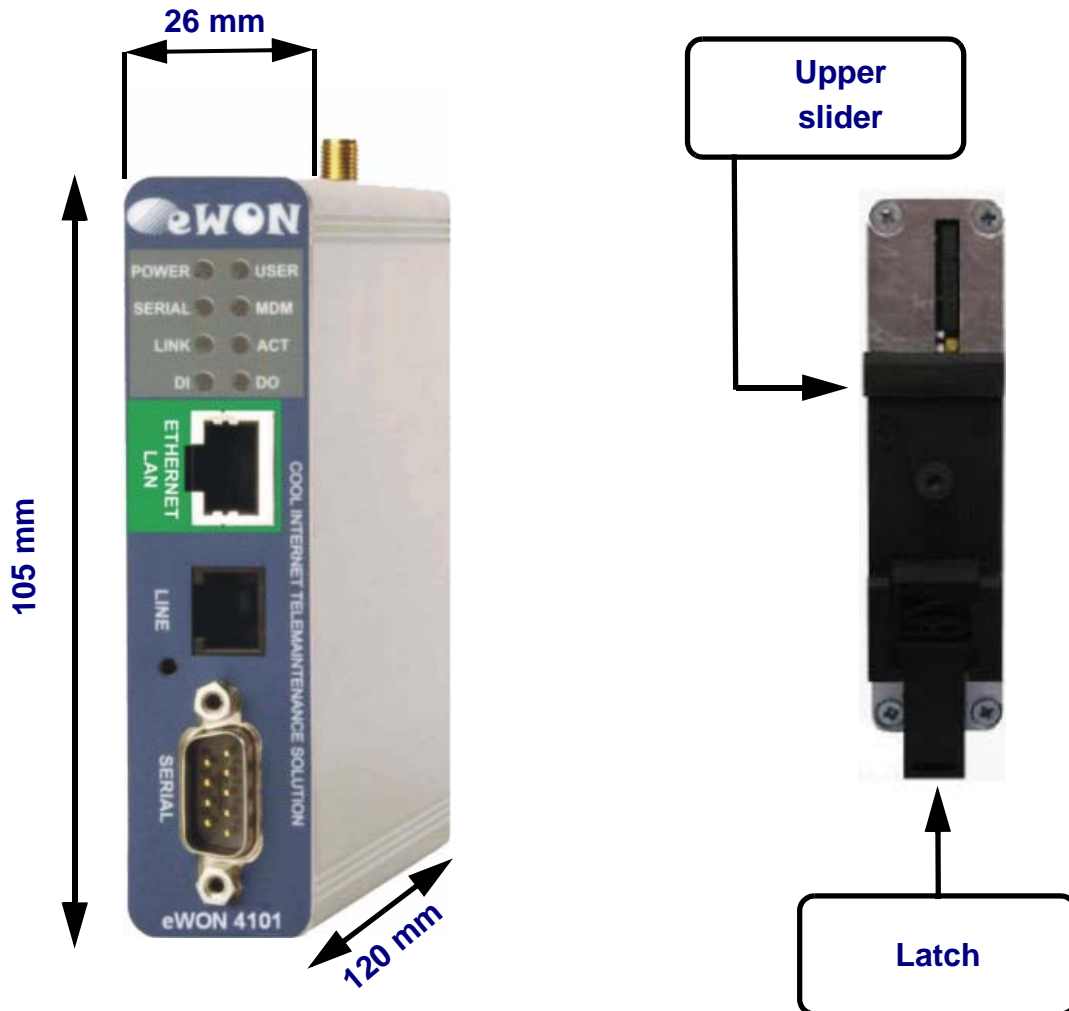

Figure 5: Left: Mechanical Outline - Right: DIN-rail latch

The eWON must be fastened on a 35mm DIN rail compliant with EN50022. A fixing latch is therefore fastened at the bottom of the housing in order to put the device in place or remove it.

To put the unit in place, insert the top slider into the upper part of the rail, with the eWON tilted around 20°. Then draw the latch at the bottom downwards with a screwdriver and at the same time put the unit right by rotating it. Release the pin, the eWON is now safely fastened.

**Important:** Be careful when mounting the unit on the DIN-rail as doing it improperly could damage either the fixing latch and/or the DIN-rail itself.

### 3.6 Mounting and environmental conditions

The eWON unit has an IP31 protection grade. It is therefore not suited for outdoor mounting. The design of the unit is such that it has to be integrated in an enclosed electrical cabinet, protected from excessive heat, humidity and dust. The eWON4101™ is complying to the CE-marking requirements regarding electromagnetic compatibility (EMC) within an industrial environment.

The normal mounting position is wall mounted on DIN-rail (EN 50022). The unit is suited to work in any other position.

The equipment will operate within specified tolerances only if the following environmental conditions are respected:

<b>Ambient temperature range</b>	0°C to +50°C
<b>Ambient humidity</b>	0-80% non-condensing

### 3.7 Preparing the installation

The recommended free space in the cabinet for the eWON should be at least: 50-mm wide x 225-mm high x 200-mm deep (terminal block excluded). A piece of rigid DIN-rail profile (flat 35mm wide) of suitable length should be firmly fastened, horizontally, in the middle of the area.

Grounding the eWON is necessary to eliminate unwanted transients (lightning protection) and to conform to the EMC requirements. Therefore, a ground screw is available at the back of the unit just below the DIN latch. Connect this screw directly to a low impedance ground.

### 3.8 Specification for external power supply selection

The eWON4101™ has to be supplied by an external voltage source ranging from 12 to 24 VDC. The power supplied must be a Class 2 or Level 3, SELV-compliant (security voltage) and limited in current to a max of 500mA. The safety voltage power supply is not part of the delivery. The data given below is intended to allow correct selection of the external power supply.

Specification	Value
<b>Secondary PS voltage</b>	from 12 to 24 VDC +/-20% (SELV-compliant)
<b>Max secondary PS current</b>	300 mA max.
<b>eWON current protection</b>	300 mA by auto fuse
<b>eWON voltage protection</b>	30V by varistor
<b>eWON EMI filter</b>	Common mode filter (*)
<b>Power absorbed (typ)</b>	5 Watts (eWON4101™ PSTN) 6 Watts (eWON4101™ GSM/GPRS)

Table 4: Specification for external power supply selection

**(\*) Properly ground the unit with the earth screw at the bottom of the unit. This is a must to ensure the security and the electro mechanical compatibility (EMC) of the device.**

Equipment Supplied by Class 2 or Level 3 Power Supply.

### 3.8.1 Auto fuse

An auto fuse placed just after at the power input protects the eWON devices against short circuits. This component returns by itself to its normal state when the short circuit has disappeared and after the component has been cooling down. Would this fuse happen to operate, please check the device for presence of loose metal parts inside likely to generate a short circuit. If the problem recurs even after such a verification, then return the device to the vendor for further investigation.

## 4 Front panel control LEDs

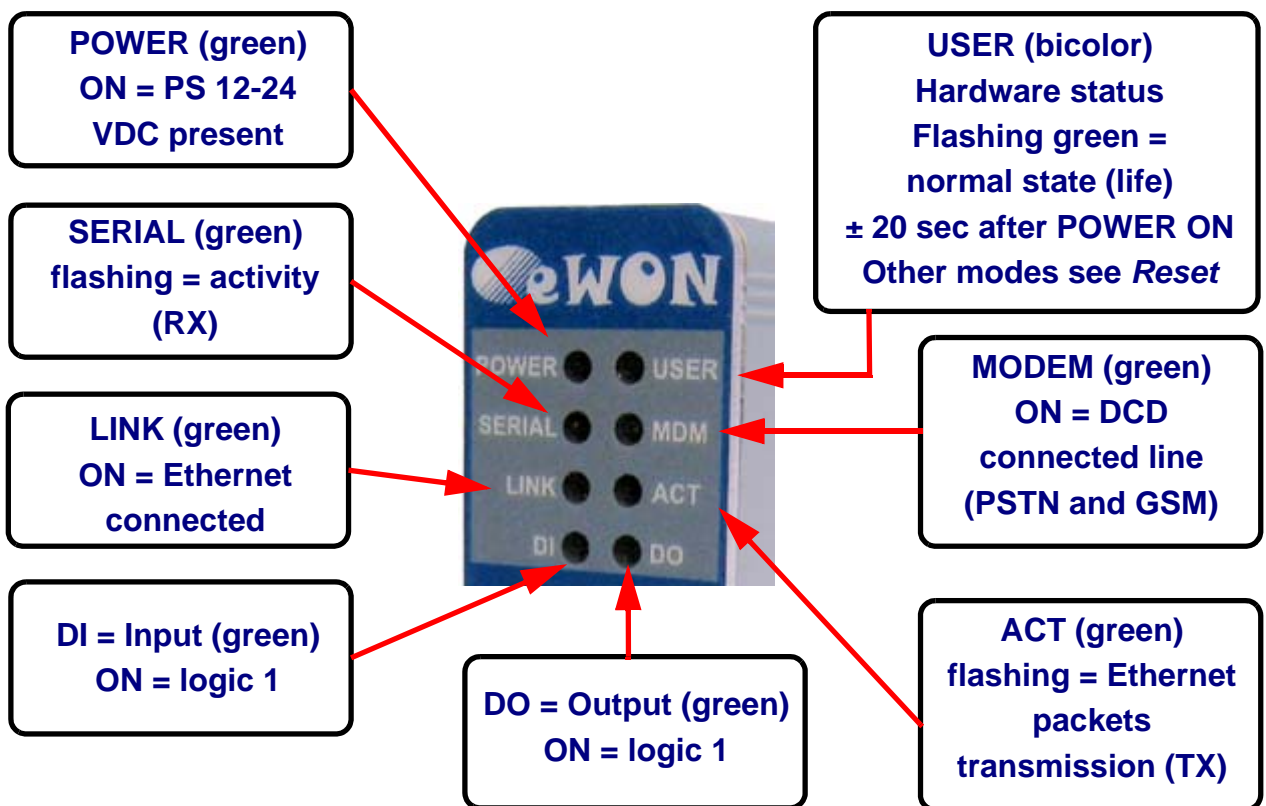

Figure 6: Front Panel leds description

## 5 Communication interfaces and I/Os

### 5.1 Ethernet Port

Specification	Value
Applicable standard	10/100BaseTX
Isolation	1,5 kV
Pinout RJ45 connector	See label and appendix ( <i>RJ45 connector on page 28</i> )

Table 5: Ethernet port specification

Please refer to the appendix (Direct connection on page 26 and Connection over hub/router on page 27) for information on the different Ethernet connexion modes (straight and crossed cables).

### 5.2 Embedded PSTN Modem

Specification	PSTN 33	PSTN 56 LS
Max baud rate	(V34) 33.600 bps	(V92) 56.000 bps
Compliant to standards	47 CFR part 68 (USA) CTR-21 (EUR)	
Approved by	TÜV Rheinland USA	
Certificate number	AU7MD01BMC56	
Pinout phone line connector	See label and appendix (PSTN / ISDN phone line connector on page 33)	
Leased Line mode	No	Yes

Table 6: PSTN modem specification

### 5.3 Embedded GSM/GPRS Modem

Specification	GSM/GPRS	GSM/GPRS US
Bands	Dual-band EGSM900/1800 MHz	950/1900 MHz
GPRS Class	Class 10	
Max baud rate	14.400 bps	
Compliant to standards	R&TTE + GCF	
Certificate number	---	
Antenna connector	Type SMA-F	

Table 7: PSTN modem specification

### 5.3.1 Recommendations for the GSM/GPRS antenna

A dual band GSM/GPRS antenna is available as accessory (ref EW40902). Here are our recommendations if you prefer to supply this antenna by yourself:

Specification	Value
Description	GSM/DCS gain GSM antenna Dual band 900/1800 MHz
Gain dB	+2 dB @ 900 MHz +0 dB @ 1800 MHz
Max antenna cable length (recommended)	5m
Antenna cable termination required to be compatible with the eWON	SMA-M Warning: adapter SMA-M/FME-M to be inserted if antenna has FME-F termination (available as spare)

Table 8: Recommendations for the GSM/GPRS antenna

### 5.3.2 SIM-card installation

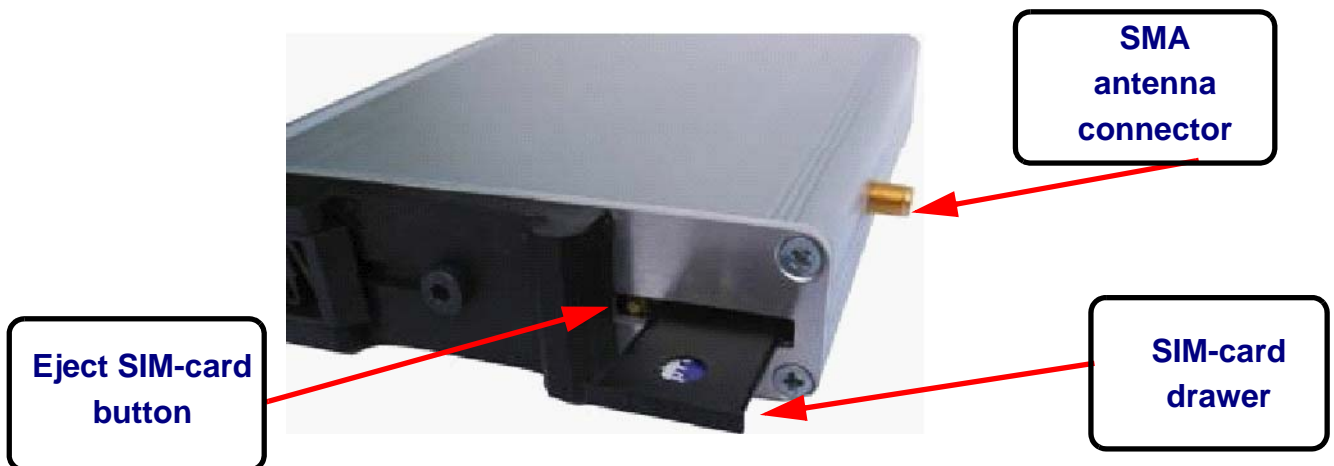

Figure 7: SIM-card insertion

### 5.4 Embedded ISDN Modem

Specification	Value
ISDN specification	ISDN BRI S0.I.430
Type	1B+D
Max baud rate	64 Kb
Certification	---

Table 9: ISDN modem specification

## 5.5 Resets

**Warning: you should not reset your eWON unless you have been told to do so by someone of our technical support. The concerned files (differs depending on reset type) are totally lost and unrecoverable after being formatted.**

To press the reset button, you will need a standard ball pen to pass through the hole in the front panel.

### 5.5.1 User Reset

This is the first level and most usual level of reset. It consists in formatting only the « user file » part of the non volatile memory. The Tag configuration and the customer web site are part of the formatted files.

You generate this first level reset by pressing and maintaining the reset button during approximately 4 seconds after powering the eWON up until the « USER » LED flashes 1x per second. When this state is reached, release the button and wait approximately 20 secs until the procedure is completed. The eWON restarts automatically and is ready to communicate. This type of reset does not modify the communication parameters.

### 5.5.2 Factory Reset

This second level reset is used only exceptionally because it formats all non volatile memories and make the eWON returning to its factory defaults. This operation consists in 3 stages:

- Formatting of all non volatile memories, including all COM parameters and IP addresses
- Return to ex-factory configuration (default config)
- Full hardware auto test with result shown by the “user” LED

**Warning: you should not reset your eWON unless you have been told to do so by someone of our technical support. The concerned files (differs depending on reset type) are totally lost and unrecoverable after being formatted.**

You generate this second level reset by pressing and maintaining the reset button during approximately 20 secs after powering up the eWON until the “USER” LED remains RED continuously. When this state is reached, release the button and wait approximately during 45 secs until the procedure is completed. The procedure finishes with the result of the autotest on the “user” LED. If the autotest is completed succesfully, then the “user” LED shows its normal pattern of 200ms ON et 1,5 sec OFF.

Any other pattern will start with 200ms ON (opening of the pattern) followed by OFF and a certain number of times 1 sec ON that allows to identify the nature of the detected problem. Please call the technical support if you are confronted with an error pattern on the “user” LED.

**Warning: you absolutely have to wait until the full autotest procedure is completed without interrupting it. If the autotest is interrupted, the flash memory of the eWON will contain random data likely to make it unstable. In such a case you have to redo the full reset procedure from scratch and wait until it is totally completed.**

When performing a full reset, the eWON does NOT restart in normal mode by itself and remains running in diagnose mode. Power the eWON off and on again to restart in normal mode. As described before, the eWON returns to its default COM parameters and IP addresses after this level 2 reset is performed.



## 5.6 Configurable serial port

Specification	Value
Physical modes (configurable)	RS232/RS485/RS422
Max serial cable length	3m
Pinout connector	See label and appendix ( <i>Serial Port on page 30</i> )

Table 10: Serial port specification

The configuration of the physical serial mode is done by a set of 4 dip switches located on left side from the unit. The settings of the switches are shown in the table below (note: switch 1 is the most right one).



Positions	Mode
4 3 2 1 OFF  ON	RS232
4 3 2 1 OFF  ON	RS422, RS485 WITHOUT polarisation and termination resistors
4 3 2 1 OFF  ON	RS422, RS485 WITH polarisation and termination resistors

Table 11: Serial mode configuration switches

**Note:** the 3 switch configurations shown here above are the sole configurations giving satisfactory results. See important remarks about this configuration on the next page.

**Warning:** Contrary to indications on the label, the switch 2 is reserved and must stay OFF. Note that switch 3 & 4 need to have the same position (both ON or both OFF). When they are ON, it connects the internal polarisation (typ 680 Ohms) and termination (typ 120 Ohms) resistors. This configuration applies only to RS4xx lines conforming to good practices.



## 5.7 MPI port

The MPI port is easily identifiable with its blue square surrounding the gender-changer dongle.

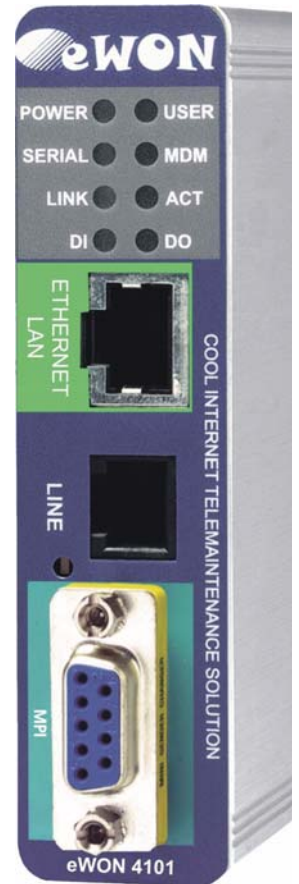
Specification	Value
Physical mode	MPI
Speed	<ul style="list-style-type: none"> <li>• 19.2 kBauds</li> <li>• 187.5 kBauds</li> <li>• 1.5 MBauds</li> </ul>
Polarisation	680 Ohms (selectable)
Termination	120 Ohms (selectable)
Pinout connector	See label and appendix (MPI port on page 31)



Dipswitch positions available

Positions	Mode
<div style="display: flex; justify-content: space-around; margin-bottom: 5px;"> <span>4</span><span>3</span><span>2</span><span>1</span> </div>  <div style="display: flex; align-items: center;"> <div style="margin-right: 10px;">OFF</div> <div style="margin-right: 10px;">ON</div> </div>	<p><b>MPI</b> WITH polarisation and termination resistors</p>
<div style="display: flex; justify-content: space-around; margin-bottom: 5px;"> <span>4</span><span>3</span><span>2</span><span>1</span> </div>  <div style="display: flex; align-items: center;"> <div style="margin-right: 10px;">OFF</div> <div style="margin-right: 10px;">ON</div> </div>	<p><b>MPI</b> WITHOUT polarisation and termination resistors</p>

## 5.8 Digital input

Specification	Value
Input voltage range	0 to 24 VDC
Input voltage absolute max (varistor protection)	33 VDC
Zero state max input voltage (OFF)	5 VDC
One state voltage range (ON)	10 to 30 VDC
One state currents (ON)	3.8mA @ 12VDC 8.2mA @ 24VDC
Isolation	3,5 kV
Pinout connector	See label and appendix ( <i>Input/Outputs on page 29</i> )

Table 12: Specification of the digital input

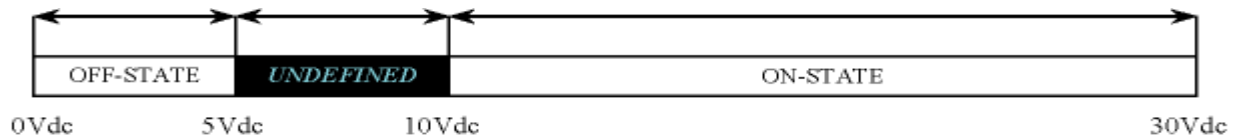

Figure 8: Digital input: state vs voltage

The input range extends from 0 to 24VDC (30VDC max). A zero logic (OFF) state is detected when the input level is below 5Vdc. A one logic (ON) state is detected when the input level is above 10Vdc.

**Warning: the logic level is undefined when the input is ranging between 5 and 10VDC.**

## 5.9 Digital output

Specification	Value
Type of output	Open collector
Max current (external source)	200mA @ 30 VDC
Isolation	3,5 kV
Pinout connector	See label and appendix ( <i>Input/Outputs on page 29</i> )

Table 13: Specification of the digital output

This digital output is activated by an open collector transistor driven by an optocoupler. The maximum current flow into this transistor has a characteristic above the value specified in the eWON, in order to cope with the switching power losses. The transistor used is in an open collector type with pre drive. This means the relay power supply has to be supplied from an external source to the pre drive electronics.

The diagram below shows the external wiring needed for correct operation of the digital output. A relay has been chosen for this sample application but any load within the specifications can be used instead.

**Warning: note that this is a sink only output to ground (the transistor acts like a switch to ground).**

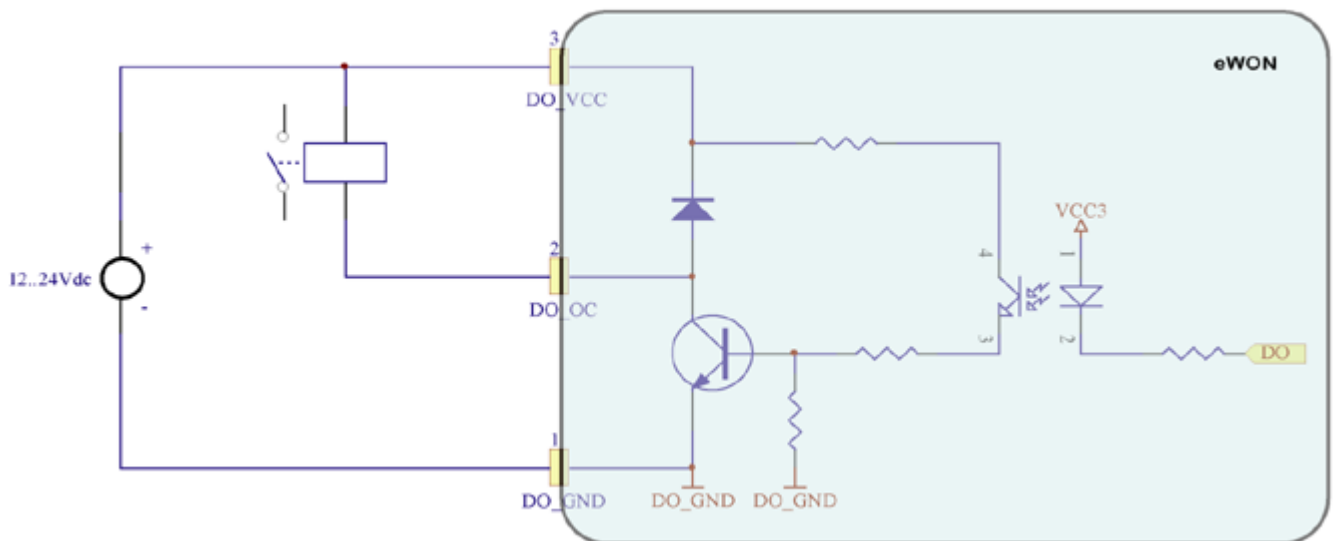

Figure 9: Digital output: wiring diagram

---

## 6 Communicating with the eWON

---

### 6.1 By Ethernet

- 1 ) Plug one of the Ethernet cables [see appendix (*Direct connection on page 26* and *Connection over hub/router on page 27*)] between your eWON and either your PC (crossed cable) or onto your network (straight cable).
- 2 ) Configure your Internet browser connection, in order not to use a proxy server (please have a look at your browser help file).  
With a direct connection between PC and eWON, TCP/IP settings have to be with fixed IP addresses and hence cannot have DHCP enabled (automatic IP address allocation by host).
- 3 ) Launch your Internet Browser on your PC.
- 4 ) Type the eWON TCP/IP address on the address edit control of your Internet Browser (10.0.0.53 is the factory default by Ethernet).
- 5 ) The eWON returns its login web page. If not -404 Error, server not found-, redo the procedure from the beginning and check whether you did not forget anything.
- 6 ) Introduce the default login parameters that are:
  - **User Name:** <adm>
  - **Password:** <adm>
- 7 ) You can now access the different web pages of the eWON and, among others, configure your connection parameters by selecting the following options in the menu of the home page:

To configure the Ethernet IP address:

<Configuration>, <System Setup>, <Communication>, <Ethernet>

To configure the PPP IP address:

<Configuration>, <System Setup>, <Communication>, <DialUp (PPP)>

### 6.2 By phone line or GSM

#### 6.2.1 Under Windows 98, NT and 2000

- 1 ) Open the root folder **Dial-up Networking**.
- 2 ) Click on the icon **Make new connection**.
- 3 ) Give a name to this connection.
- 4 ) Select a local modem from the list and click **Next**.
- 5 ) Introduce the **phone number** and the login <adm> and password <adm> of your eWON (or the login/password you have created) and click **Next**.
- 6 ) Click **Finish**.
- 7 ) An new icon has been created in the **Dialup Networking** folder.
- 8 ) Open the connection wizard by double clicking on this icon and introduce the **login/password** for PPP authentication which are the same than those for the eWON Web site access (<adm> / <adm> by default). Make the connection and wait until the modems are synchronized (MDM led on the front panel is active) and that your authentication login has been accepted.
- 9 ) Launch your Internet Browser on your PC.
- 10 ) Types the eWON TCP/IP address on the address edit control of your Internet Browser (202.0.0.240 is the eWON but you could have modified, in this case use the new address).
- 11 ) The eWON should display its login web page. If not -404 Error, server not found-, redo the procedure from the beginning and check whether you did not forget anything.
- 12 ) Unless you have changed them, introduce the default Web site access login parameters that are:
  - **User Name:** <adm>
  - **Password:** <adm>

13 ) You can now access the different Web pages of the eWON and, among others, configure your connection parameters by selecting the following options in the menu of the home page:

To configure the Ethernet IP address:

<Configuration>, <System Setup>, <Communication>, <Ethernet>

To configure the PPP IP address:

<Configuration>, <System Setup>, <Communication>, <DialUp (PPP)>

## 6.2.2 Under Windows XP

- 1 ) With Windows XP, you first have to go to **Start** and select **Connect to** and then **Show all connections**. **Create a new connection** appears in the network tasks box (top left corner).
- 2 ) Selecting **Create a new connection** menu opens the new connection creation wizard. Click **Next**.
- 3 ) Select the 2<sup>nd</sup> option (out of 4) – **Connect to the network at my workplace** and then click **Next**.
- 4 ) Select the 1<sup>st</sup> option (out of 2) – **Dial-up connection** and click **Next**.
- 5 ) Give a **name** to this connection and click **Next**.
- 6 ) Introduce the **phone number** of the eWON and click **Next**.
- 7 ) Click **Finish**.
- 8 ) The connection windows opens and introduce the PPP authentication parameters that are the same than those used to access to the eWON embedded Web site (<adm> / <adm> by default).
- 9 ) The new connection has now been added in the "Connections" directory and also under **Start** and **Connect to** as well as on your desktop if you selected the relevant option (**Create icon on desktop**).
- 10 ) You can now make a connection either by using the currently open window, or later on by using one of the available paths (**Start** menu or desktop icon).
- 11 ) Wait until the modems are synchronized and that your PPP authentication has been accepted.
- 12 ) Launch your Internet navigator.
- 13 ) Introduce the IP address of the eWON in the address field of the navigator (the default address is 202.0.0.240 in dial-up mode (see chapter *IP parameters configuration on page 23*).
- 14 ) The eWON should then display its login Web page. If not (-404 Error, server not found-), redo the procedure from the beginning and check whether you did not forget anything.
- 15 ) Unless you have changed them, introduce the default web site access login parameters that are:
  - **User Name:** <adm>
  - **Password:** <adm>

16 ) You can now access the different Web pages of the eWON and, among others, configure your connection parameters by selecting the following options in the menu of the home page:

To configure the Ethernet IP address:

<Configuration>, <System Setup>, <Communication>, <Ethernet>

To configure the PPP IP address:

<Configuration>, <System Setup>, <Communication>, <DialUp (PPP)>

---

## 7 IP parameters configuration

---

**Warning: parameters always have to be defined in full agreement with the network policies applicable within your organisation (ask your network administrator).**

The Ethernet port of the eWON is configured in the factory with the following default parameters:

- **IP Address: 10.0.0.53**
- **Subnet mask: 255.255.255.0**
- **Gateway: 0.0.0.0 (none)**

**Note: the default IP address for dial-up access (PPP) is different (202.0.0.240). This allows simultaneous connection through both interfaces.**

Whatever the access mode is (direct or dial-up), you will need these IP parameters to communicate with the eWON. If your device is inserted in a local network (LAN), one of the first things to do is to assign the device IP parameters that are compatible with your network (ask your network administrator). The following chapter describes how to edit these parameters by using the *eBuddy* utility. You can also edit the IP parameters with your navigator and the Web site included in the eWON.

**Warning: normally you cannot communicate with a device of which you don't know the IP parameters. Therefore, there is a special tool (called "eBuddy") you can download from the eWON Internet site <http://www.ewon.biz>. Start this application once you have connected your eWON to the network. The application will scan the whole network and will identify all eWONs that are connected, including their IP parameters (Address and subnet mask) and their serial number. The utility allows also to edit the IP parameters. IP parameters always have to be defined in full agreement with network policies applicable within your organisation (ask your network administrator).**

When connecting through a modem, the eWON assigns a client address to the PPP interface of your PC. This address has to be configured outside the range of addresses used within the LAN network of your organisation (ask your network administrator). For example, if your organisation has 10.0.0.0 as basis address and 255.255.255.0 as subnet mask, then you can use any address between 10.0.0.0 et 10.0.0.255. Contact your network administrator in order to obtain an IP client address that is compatible with those of your organisation.

## 8 Technical support

If you need technical support, simply fill out the form on the Web site <http://www.ewon.biz> or send an email with the problem description to [support@ewon.biz](mailto:support@ewon.biz).

## 9 Appendix: Pinouts and connections

### 9.1 Power Supply

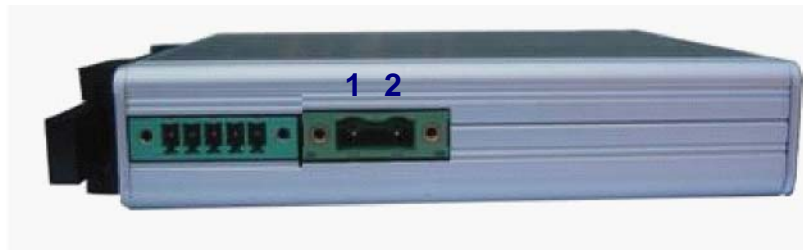

Figure 10: eWON Mating female connector (included)

- **Manufacturer:**  
Phoenix Contact GmbH, <http://www.phoenixcontact.com>  
Part Number: GMSTB 2,5/2-STF-7,62
- **Pinout (see label)**

Pin	Description
1	Ground
2	Positive (+)

Table 14: Pinout Power Supply Connector



## 9.2 Ethernet

The eWON can be accessed by a 10/100BaseTX Ethernet connection. This connection can be made with two different cables (straight or crossed). These cables have 8 copper conductors and are known as UTP Class 5 with RJ45 terminations at both ends.

These cables are available as spare parts (see *External accessories on page 6*).

The type of cable (straight or crossed) depends on the equipment the eWON will be connected to. The most current cases are the direct connection with a PC (crossed) and the connection through a hub/router (straight).

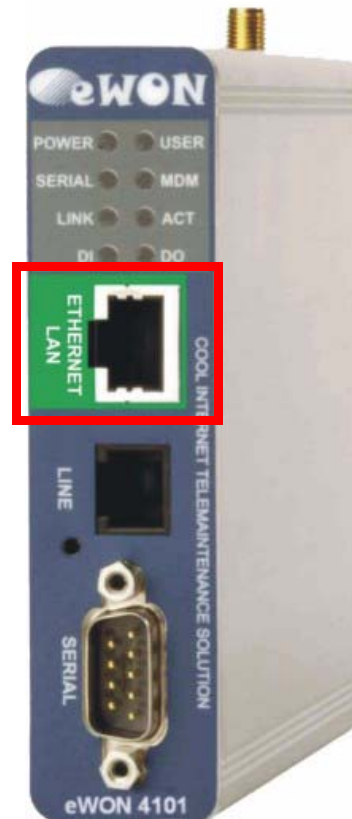

## 9.2.1 Direct connection

If the eWON is connected directly to a PC, then use the crossed cable:

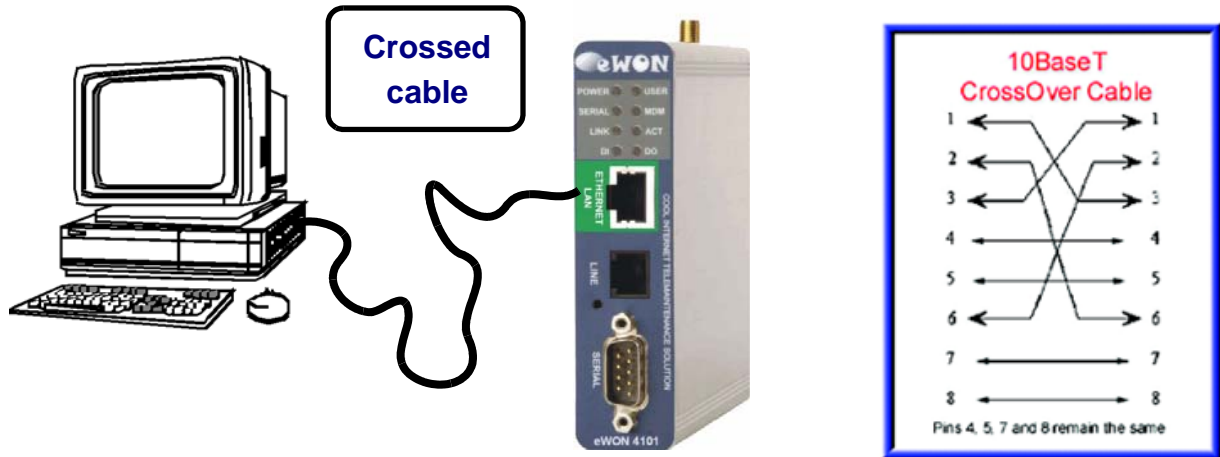

When cabling over long distance, you have to take care of the twisted pairs. This means that along with the above cabling conventions, the emission (TX+/TX-) and reception (RX+/RX-) signals have to be connected on the same twisted pair:

<b>TX+: pin3, TX-: pin6</b>	Twisted pair 1
<b>RX+: pin1, RX-: pin2</b>	Twisted pair 2

Pins 4, 5, 7 and 8 do not have to be connected. The following picture shows the twisted pair connections:

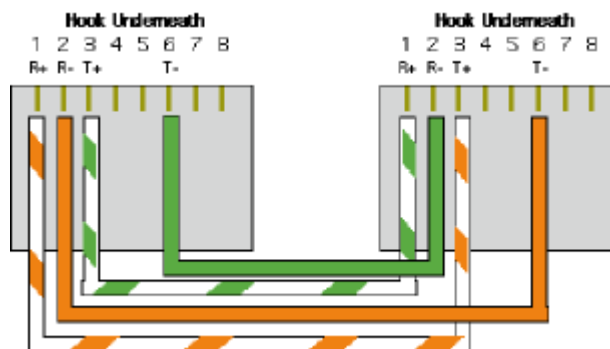

## 9.2.2 Connection over hub/router

If the eWON is connected to a hub, it has to be connected like any other device, with a straight cable. Again, the wiring is as shown on the following picture, and care should be taken to keep the RX and TX signals on twisted pairs:

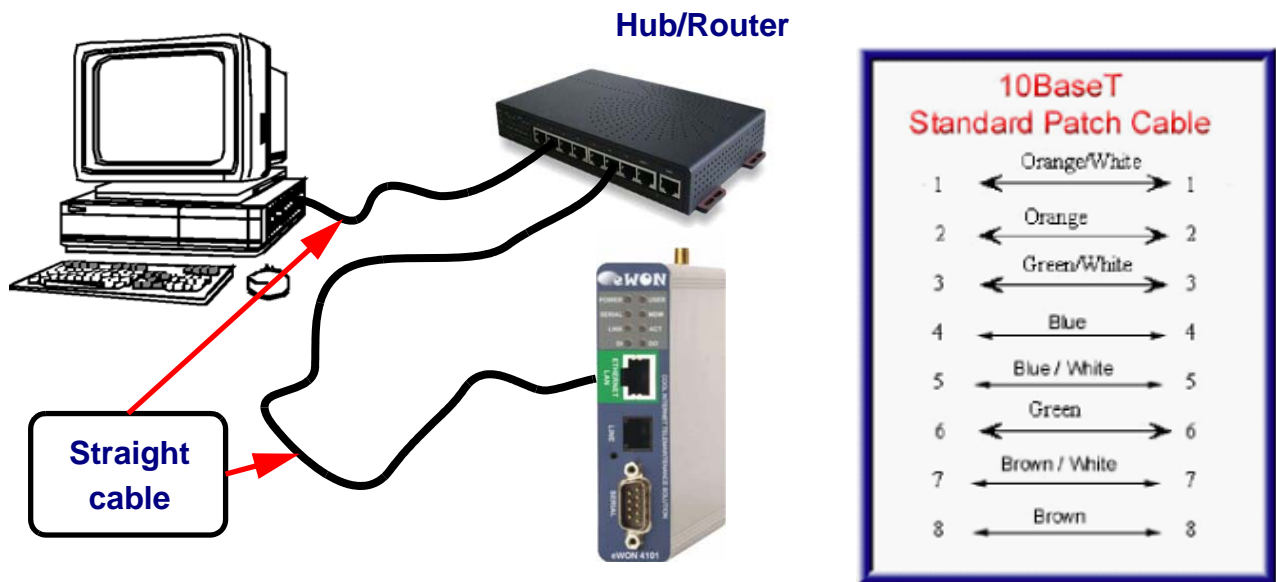

## 9.3 RJ45 connector

The RJ45 connector has got the following pins numbering, as it can be seen on the following picture, showing it from different angles:

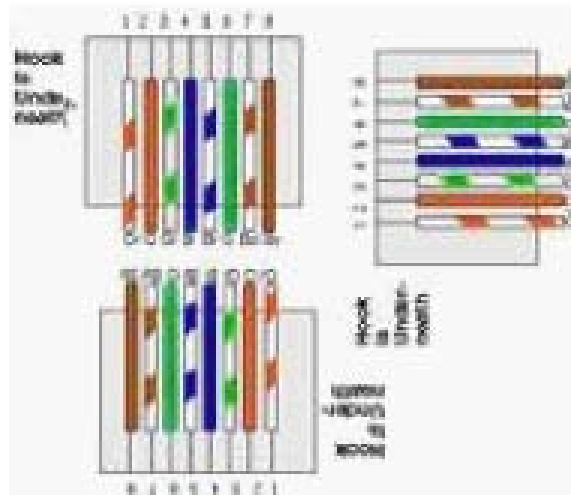
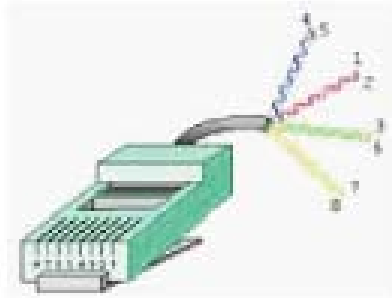

## 9.4 Input/Outputs



Mating female connector (included):

<b>Manufacturer:</b>	Sauro	<a href="http://www.sauro.net/">http://www.sauro.net/</a>
<b>Part Number:</b>	CTF050VT	

Pin	REF	Description
1	DO_GND	Output digital signal (0V ground) connected to the emitter of the transistor
2	DO_OC	Output digital signal connected to the collector of the transistor
3	DO_VDC	Common of the external predrive power supply (between +12 et +24 VDC)
4	DI_GND	Ground of the input (isolated)
5	DI	Input digital signal

Table 15: Pinout I/O connector

## 9.5 Serial Port

Mating female connector (not included):



<b>Type</b>	Female DB9 with 4/40 blocking screws
-------------	--------------------------------------

Pinout serial port (according to mode):

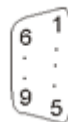

Pin	RS232	RS485	RS422
1	-	-	-
2	RXD	-	RX+
3	TXD	A+	TX+
4	-	-	-
5	GND	GND	GND
6	-	-	-
7	RTS	-	RX-
8	CTS	B-	TX-
9	-	-	-

Table 16: Pinout serial port

## 9.6 MPI port

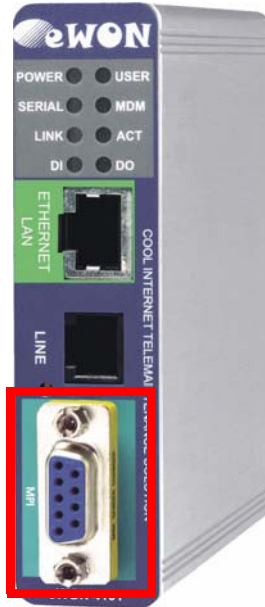

Mating male connector (not included):

<b>Type</b>	Male DB9 with 4/40 blocking screws
-------------	------------------------------------

**MPI port pinout (DB9 female):**

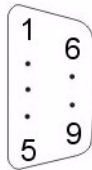

Pin	MPI
1	-
2	-
3	B(+)
4	-
5	GND
6	-
7	-
8	A(-)
9	-

Table 17: MPI port

## 9.7 Unitelway/Modbus serial cable

This 2m cable can be delivered as accessory to connect Schneider PLCs; It has a SUBD9 connector at the eWON side and a MiniDIN connector at the PLC side.

Twido Din Socket Pinout

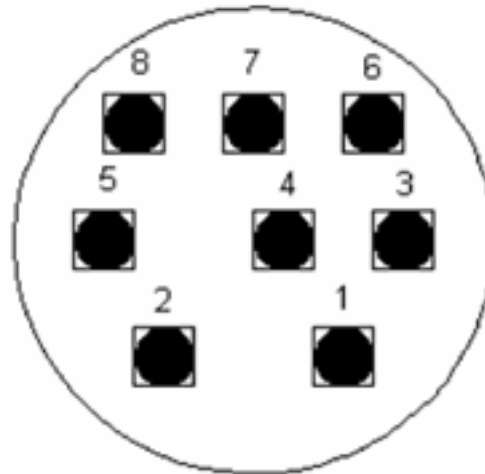

MiniDIN PIN	Schneider Signal Name	eWON Signal Name	eWON SUBDB9 Pin
1	D(B)	A+	DB9 pin 3: A+
2	D(A)	B-	DB9 pin 8: B-
3			
4			
5			
6			
7	GND	GND	DB9 pin 5: GND
8			
Connector Shield			

Table 18: Pinout MiniDIN

D(A) is connected to **B-** and D(B) is connected to **A+**



## 9.8 PSTN / ISDN phone line connector

- Mating male connector (not included):

<b>Type:</b>	RJ11 type "6P2C" without shield
--------------	---------------------------------

- Pinout PSTN line:

Pin	Description
1	-
2	-
3	TIP
4	RING
5	-
6	-

Table 19: pinout PSTN modem

- ISDN phone line mating male connector pinout (RJ11):

Pin	Description
1	-
2	TX+
3	RX+
4	RX-
5	TX-
6	-

Table 20: ISDN connector pinout

